

JADEMAR®

I G H T I N G

JWP-FC SERIES FULL CUT-OFF WALL PACK



Product Description

The JWP-FC Series of Full Cut-Off Wall Packs is designed for maximum adaptability in a vast range of commercial and industrial applications and rugged service environments.

With weatherproof housings, these LED luminaires are a versatile and durable outdoor luminaires. Long-lasting, high-efficiency LEDs provide energy savings and maintenance costs compared to traditional HID Wall Packs.

Features

- Construction is composed of ADC12 Aluminum Heat Sink with Powder Coat Finish
- Polycarbonate Optical Lens emits High Lumen Output, Anti-UV Rays and Fire Resistant
- Aluminum LED Board is highly conductive, waterproof, aging resistant, and salt corrosion resistant.

Certifications & Compliance



Performance Summary

Input Power	12W / 30W / 38W / 50W / 80W / 120W
Efficacy	124 Lms/W Average
CCT Options	3000K / 4000K / 5000K
Construction	Powder Coat Cast Aluminum Body / UV Stable Polycarbonate Lens
Input Voltage	100-277VAC or 387-480VAC
Control	0-10VDC Dimming for 38W, 80W, 100W, 120W Knockout for Dusk-to-Dawn Photo Sensor
Ingress Protection	IP65
Lifetime Based on TM21	L70 @ 187,000Hrs / L80 @ 162,000Hrs / L90 @ 138,000Hrs
Certifications & Compliance	UL / cUL / DLC Premium/ FCC
Warranty	10 Year Limited

Product Dimensions

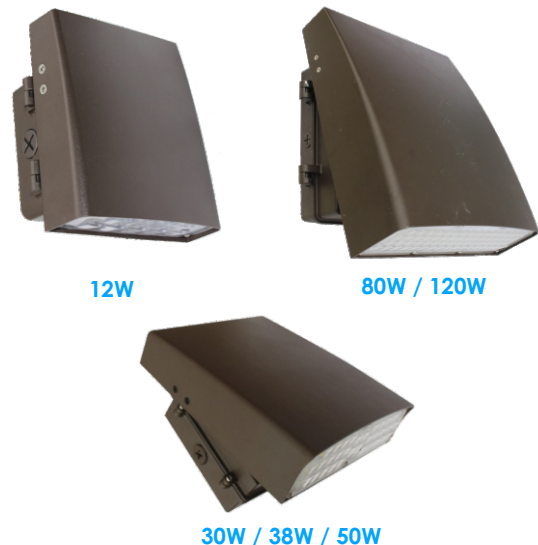
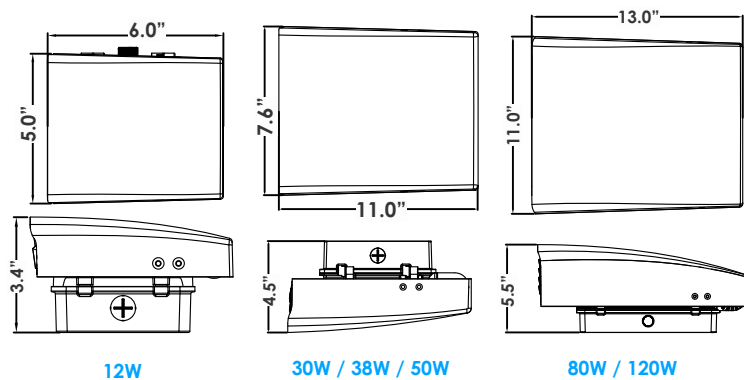

Miami, FL USA - info@jademar.com
T: 305.640.0465 - F: 305.640.0468
WWW.JADEMAR.COM



Information contained herein is subject to change without notice.
Values are nominal. All values conform to DLC tolerances.
Revised 03/2021

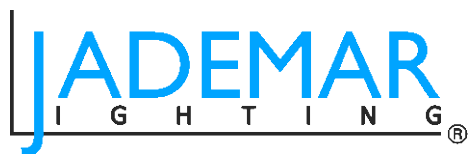

SPECIFICATION SUBMITTAL DETAIL

Project Name/Type:		Date:
Catalog/Part #:		

JWP-FC FULL CUT-OFF WALL PACK SERIES

Ordering Information / Example: **JWP-FC-38W-H-40K-D-BZ**

Product	Input Voltage	CCT/Color Temp.	Controls & Dimming	Finish
JWP-FC-12W JWP-FC-30W JWP-FC-38W JWP-FC-50W JWP-FC-80W JWP-FC-120W	Blank (120-277V) H (347-480V)* *38W Only	30K (3000K) 40K (4000K) 50K (5000K)	N - (Non Dim 12W, 30W, 50W) D - (0-10V Dimming 38W, 80W & 120W) PC (Photocell ON/OFF, 120V-277V)	BZ (Bronze) Standard B (Black) WH (white) <i>Special Order</i>

Field Installed Options

PC	Photocell ON/OFF, 120V-277V
----	-----------------------------

Electrical Data Table

Model	JWP-FC-12W	JWP-FC-30W	JWP-FC-38W-H	JWP-FC-50W	JWP-FC-80W	JWP-FC-120W
Nominal Watts	12W	30W	38W	50W	80W	120W
Nominal Efficacy (Lms/W)	113.09	121.93	127.69	123.92	130.98	126.39
Lumens @ 3000K (Type 3)	1367	3612	4551	6147	10336	14901
Lumens @ 4000K (Type 3)	1367	3612	4551	6147	10336	14901
Lumens @ 5000K (Type 3)	1368	3667	4606	6206	10507	15113
Lumens @ 5700K (Type 3)	1335	3695	4633	6235	10592	15219
Luminaire Dimensions (L x W)	6" x 5" x 3.4"	11" x 7.6" x 4.5"	11" x 7.6" x 4.5"	11" x 7.6" x 4.5"	13" x 11" x 5.5"	13" x 11" x 5.5"
Weight	3.03 lbs.	7.15 lbs.	7.15 lbs.	7.15 lbs.	11.58 lbs.	11.58 lbs.
Input Voltage	120-277VAC	120-277VAC	347-480VAC	120-277VAC	120-277VAC	120-277VAC
Power Factor	>0.93					
CCT	3000K / 4000K / 5000K					
CRI	>73.5					
Ambient Working Temp.	-20°C ~+40°C (-4°F ~ +104°F)					
THD @ 120VAC	≥13%					
BUG Rating	B1-U0-G0					
Lifetime Based on TM21	L70 @ 187,000Hrs / L80 @ 162,000Hrs / L90 @ 138,000Hrs					
Ingress Protection (IP)	IP65 Rated					
Standard Control Specification	N/A	0-10V Dimming		N/A	0-10V Dimming	
Beam Angle	80° x 100°					
Construction	Powder Coat Cast Aluminum / UV Stable Polycarbonate Lens					
Certifications & Compliance	UL / DLC Listed/ FCC/ RoHS					
Limited Warranty	10 Years Limited Warranty					



Miami, FL USA - info@jademar.com
T: 305.640.0465 - F: 305.640.0468
WWW.JADEMAR.COM



Information contained herein is subject to change without notice.
Values are nominal. All values conform to DLC tolerances.
Revised 03/2021

PHOTOMETRIC DETAIL

JWP-FC-12W

Lum. Classification System (LCS)

LCS Zone	Lumens	%Lamp	%Lum
FL (0-30)	217.7	N.A.	17.4
FM (30-60)	355.1	N.A.	28.4
FH (60-80)	86.2	N.A.	6.9
FVH (80-90)	3.8	N.A.	0.3
BL (0-30)	200.4	N.A.	16.0
BM (30-60)	302.9	N.A.	24.2
BH (60-80)	76.3	N.A.	6.1
BVH (80-90)	7.5	N.A.	0.6
UL (90-100)	0.0	N.A.	0.0
UH (100-180)	0.0	N.A.	0.0
Total	1249.9	N.A.	100.0
BUG Rating	B1-U0-G0		

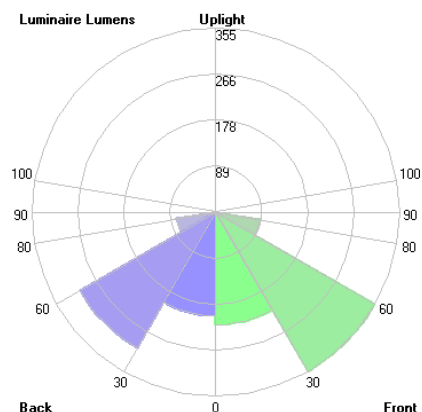
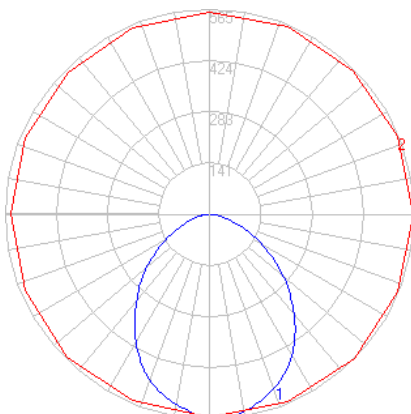

JWP-FC-30W

Lum. Classification System (LCS)

LCS Zone	Lumens	%Lamp	%Lum
FL (0-30)	544.3	N.A.	17.1
FM (30-60)	853.4	N.A.	26.8
FH (60-80)	202.7	N.A.	6.4
FVH (80-90)	8.2	N.A.	0.3
BL (0-30)	531.1	N.A.	16.7
BM (30-60)	815.3	N.A.	25.6
BH (60-80)	206.0	N.A.	6.5
BVH (80-90)	19.8	N.A.	0.6
UL (90-100)	0.0	N.A.	0.0
UH (100-180)	0.0	N.A.	0.0
Total	3180.8	N.A.	100.0
BUG Rating	B2-U0-G1		

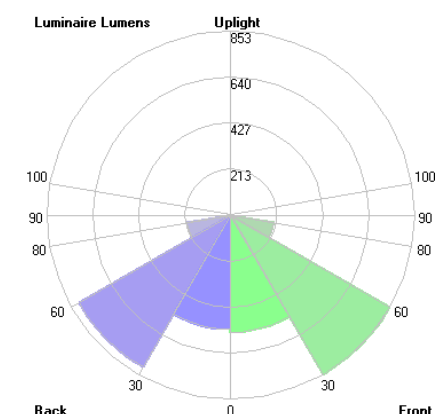
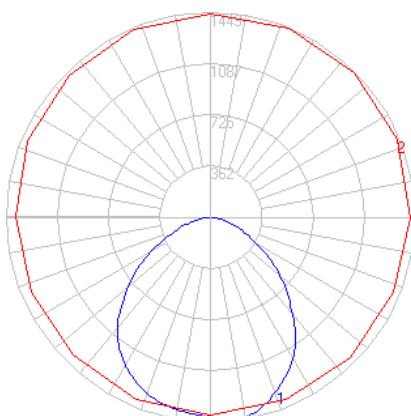

JWP-FC-50W

Lum. Classification System (LCS)

LCS Zone	Lumens	%Lamp	%Lum
FL (0-30)	945.4	N.A.	18.5
FM (30-60)	1632.8	N.A.	32.0
FH (60-80)	424.5	N.A.	8.3
FVH (80-90)	24.0	N.A.	0.5
BL (0-30)	751.2	N.A.	14.7
BM (30-60)	1037.7	N.A.	20.4
BH (60-80)	256.9	N.A.	5.0
BVH (80-90)	26.4	N.A.	0.5
UL (90-100)	0.0	N.A.	0.0
UH (100-180)	0.0	N.A.	0.0
Total	5098.9	N.A.	100.0
BUG Rating	B2-U0-G1		

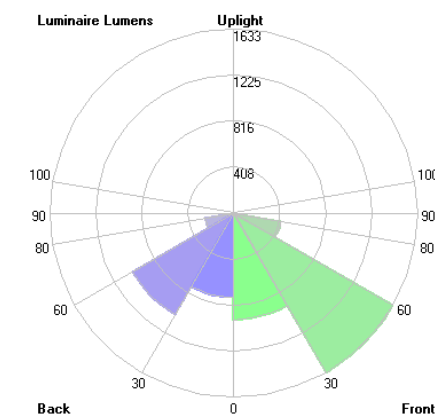
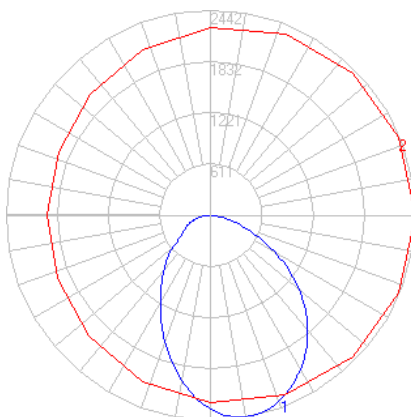

PHOTOMETRIC DETAIL

JWP-FC-80W

Lum. Classification System (LCS)

LCS Zone	Lumens	%Lamp	%Lum
FL (0-30)	1480.0	N.A.	16.7
FM (30-60)	2551.9	N.A.	28.8
FH (60-80)	663.7	N.A.	7.5
FVH (80-90)	38.3	N.A.	0.4
BL (0-30)	1530.7	N.A.	17.3
BM (30-60)	2066.3	N.A.	23.3
BH (60-80)	492.8	N.A.	5.6
BVH (80-90)	47.0	N.A.	0.5
UL (90-100)	0.0	N.A.	0.0
UH (100-180)	0.0	N.A.	0.0
Total	8870.7	N.A.	100.0
BUG Rating	B3-U0-G1		

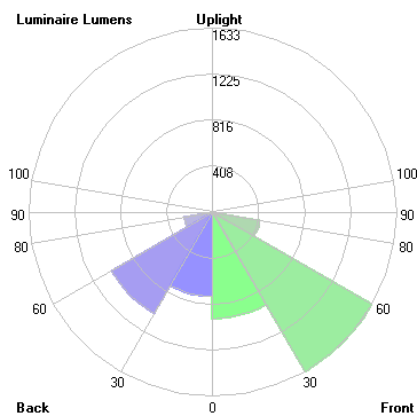
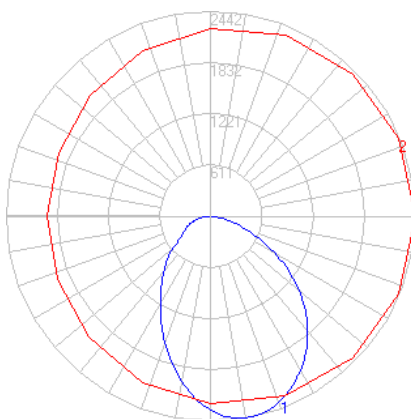

JWP-FC-120W

Lum. Classification System (LCS)

LCS Zone	Lumens	%Lamp	%Lum
FL (0-30)	2262.7	N.A.	16.2
FM (30-60)	3861.2	N.A.	27.7
FH (60-80)	1032.3	N.A.	7.4
FVH (80-90)	63.7	N.A.	0.5
BL (0-30)	2417.6	N.A.	17.3
BM (30-60)	3483.8	N.A.	25.0
BH (60-80)	760.8	N.A.	5.5
BVH (80-90)	66.3	N.A.	0.5
UL (90-100)	0.0	N.A.	0.0
UH (100-180)	0.0	N.A.	0.0
Total	13948.4	N.A.	100.0
BUG Rating	B3-U0-G2		

